



**DVD 7014**



**USER MANUAL**

# *CONTENTS*

A. Introduction	1
B. Cautions and Warnings	1
C. Important safety instructions	1
D. Contents	2
E. Powering and installation	2
F. Controls, Indicators, and Connectors	2
G. Loading and Playing a Disc	4
H. Setup	4
I. Basic Operation	8
J. Playing MP3 Audio CD Discs	12
K. Playing JPG files	12
L. Connecting to TV or another monitor	13
M. Rechargeable battery use	13
N. Specifications	14
O. Troubleshooting	14

---

## A. Introduction

Thank you for choosing our portable DVD player. The main features include a 7" Wide Screen (16:9 Aspect Ratio) Liquid Crystal Display (LCD) monitor and a DVD player. The unit applies the latest state of art electronics and is designed for use in hotels, offices or homes. The unit is constructed to provide years of reliable, trouble-free service, and is compact to take it with you anywhere and is designed for quick and easy installation. Prior to use please read the entire instruction manual supplied with this product. Please save this manual for later use.

## B. Cautions and Warnings

**Warning:** To reduce the risk of fire or electric shock, do not expose this apparatus to rain or moisture.

**Caution:** Danger of explosion if battery is incorrectly replaced. Replace only with the same or equivalent type.

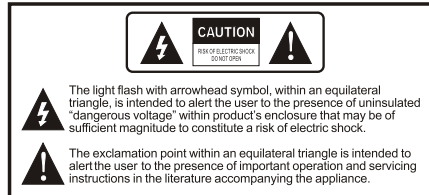

## C. Important safety instructions

- 1) Read these Instructions.
- 2) Keep these Instructions.
- 3) Heed all warnings.
- 4) Follow all instructions.
- 5) Do not use this unit near water.
- 6) Clean only with dry cloth.
- 7) Do not block any ventilation openings, Install in accordance with the manufacturer's instructions.
- 8) Do not install near any heat sources such as radiators, heat registers, stoves, or other apparatus (including amplifiers) that produce heat.
- 9) The main power switch is used as the disconnect device. It shall remain readily operable and should not be obstructed during intended use.
- 10) Protect the power cord from being walked on or pinched particularly at plugs, convenience receptacles, and the point where they exit from the unit
- 11) Only use attachments/accessories specified by the manufacturer.
- 12) Replace only with the same or equivalent type. This is a danger of explosion if battery is incorrectly replaced.
- 13) Unplug this unit during lightning storms or when unused for long periods of time.
- 14) Refer all servicing to qualified service personnel, servicing is required when the unit has been damaged in any way, such as power-supply cord or plug is damaged, liquid has been spilled or objects have fallen into the unit, the unit has been moisture, does not operate normally, or has been dropped.
- 15) Cleaning Unit  
When cleaning, make sure the system is unplugged from the power source. Do not use liquid cleaners or aerosol cleaners. Use a cloth lightly dampened with water for cleaning the exterior of the system only.
- 16) Disc  
Do not use irregular shaped discs such as heart or star-shaped discs as they may cause the unit to malfunction. Do not stick paper, tape or glue on the disc. Do not expose the disc to direct sunlight or heat sources. Do not

---

touch the surface of disc. Handle the disc by its edge. Clean the disc by wiping the disc from the center out with a cleaning cloth. Remove the disc from the unit and store it in its case after playing. Some playback operations of discs may be intentionally fixed by software producers. Since this unit plays discs according to the disc contents the software producers designed, some playback features may not be available. Also refer to the instructions supplied with the discs.

#### D. Contents

1. 1 x 7" DVD Player Combo with built-in Rechargeable lithium Polymer battery
2. 1 x Remote Control with battery
3. 1 x Audio/Video Cable
4. 1 x AC/DC Adapter
5. 1 X Cigarette Lighter Adapter
6. 1 x Instruction Manual
7. 1 X Earphone

#### E. Powering and installation

##### 1. Powering the system indoors

Plug one end of the AC to DC adapter into the DC input jack on the RIGHT side of the main unit, then plug the other end into the AC power receptacle.

##### 2. Powering the system in a car

Plug one end of the cigarette lighter adapter into the DC input jack on the unit, then plug the other end into the cigarette lighter socket

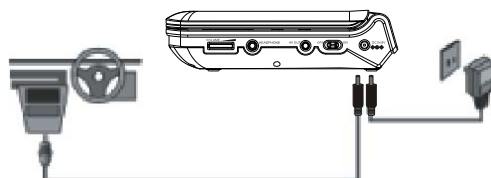

#### F. Controls, Indicators, and Connectors

##### 1. Unit View

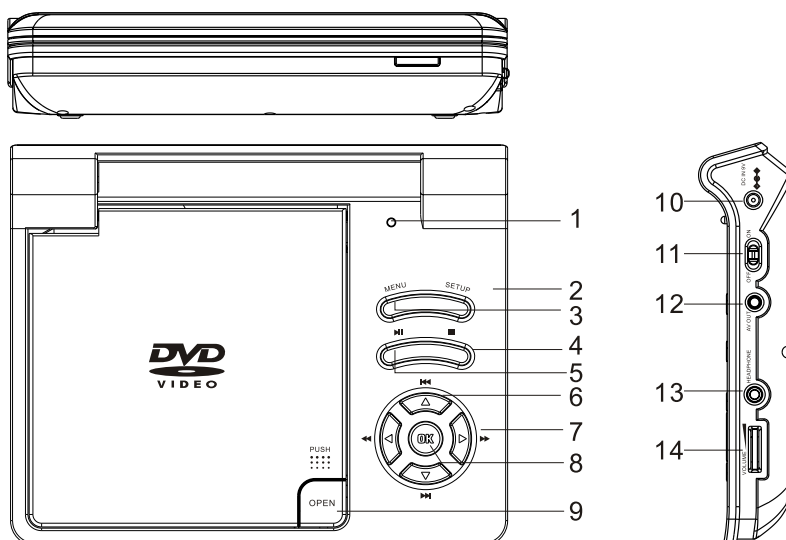

- 1.LCD Panel Shut Off Switch
- 2.SETUP
- 3.MENU
- 4.STOP ■
- 5.PLAY/PAUSE ►►
- 6.◀◀ ►► BUTTON ▲▼
- 7. ◀◀ ►► BUTTON ►◀
- 8.OK BUTTON
- 9.OPEN
- 10.DC IN
- 11.POWER ON/OFF SWITCH
- 12.AV OUT
- 13.HEADPHONE
- 14.VOLUME

2.Controls

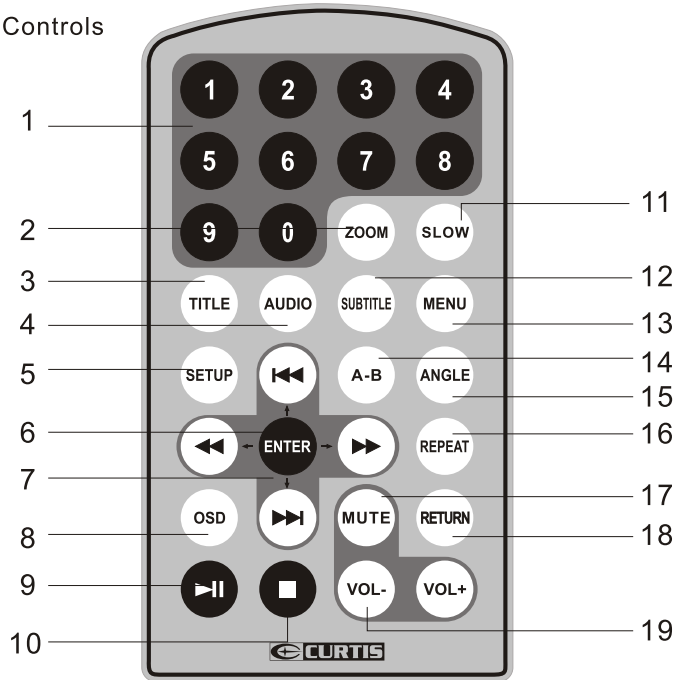

- 1.Number buttons
- 2.Zoom(To zoom in/out picture)
- 3.Title
- 4.Audio
- 5.Setup
- 6.Enter
- 7.Previous/Next(when playing) ◀◀ ►►
- Fast backward/FF (when playing) ◀◀ ►►
- Direction buttons (when at menu setup) ◀▲▼►
- 8.OSD
- 9.Play/Pause ►►
- 10.Stop ■
- 11.Slow
- 12.Subtitle
- 13.Menu
- 14.A-B
- 15.Angle
- 16.Repeat
- 17.Mute
- 18.Return
- 19.Volume + -

3. The use of Remote Control:

Please put the battery into the remote control as per below illustration

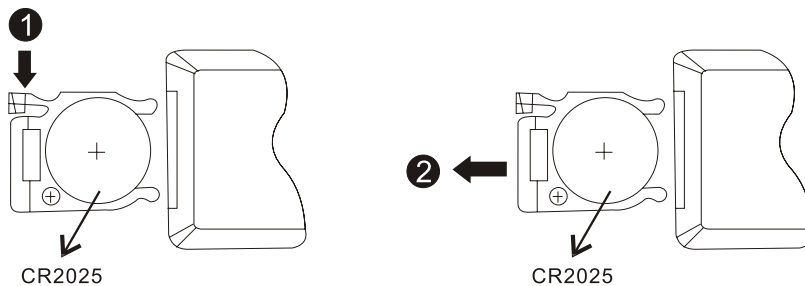

When using remote control, make sure the infrared window is pointed to infrared receiving window of the machine. The distance between machine and remote control must be within 3 metres. Please refer to the following illustration

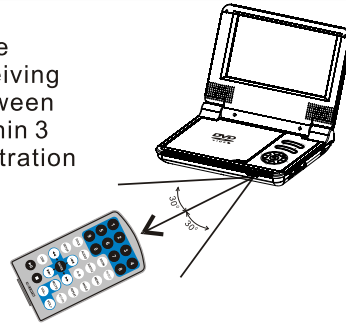

**G. Loading and Playing a Disc**

- a. After connecting power to the unit, turn on DVD player with the ON/OFF switch. The power indicator will light.
- b. Open the disc tray by "OPEN" , and place a disc into the tray with the label side facing up.
- c. Close the tray. The unit will load the disc and start playing.
- d. Adjust picture quality by entering into video quality setup via SETUP button on the unit or from the remote control.
- e. To stop playing a disc, press STOP.

**H. Setup**

Press 'SETUP' to display the Main screen of the Setup Menu on the screen. Press 'SETUP' again to exit the Setup Menu and the unit will resume its last playback mode.

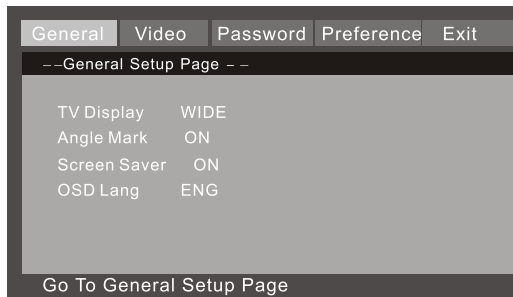

1) Press SETUP , the 'General Setup Page' will display on screen.

- a). Select 'Angle Mark' using the ▲/▼ button, and then press the ► button to enter the submenu. Choose Angle Mark on or off using the ▲/▼ button and then press OK to confirm the setting. Press the ◀ button to return.

\* On: The screen will show the angle mark icon. (\*If an angle option is available).

\* Off: The screen will not display the Angle Mark

NOTE: Not all discs contain above features. The above features are disc dependent.

- b). Select 'Screen Saver' using the ▲/▼ button, and then press the ► button to enter the submenu. Choose Screen Saver on or off using the ▲/▼ button and then press OK to confirm the setting. Press the ◀ button to return.

\*On: Enables screen saver

\*NOTE: The DVD player will enter the Screen Saver mode after approximately five minutes if the same image remains on the screen.

\*Off: Disables screen saver (off)

- C) Select 'OSD LANG' by ▲/▼ button ,and then press the ► button to enter the submenu

\*Note: OSD language is also available with the others than the listed

---

2) Select Video Quality Setup by using the ◀ / ▶ button, press OK to enter the panel quality setup page.

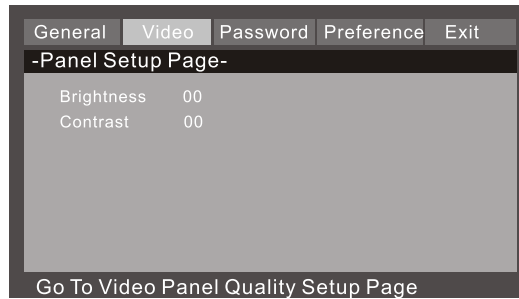

- a). Select 'Brightness' by using the ▲ / ▼ button, then press OK. You can adjust the Brightness by pressing the ◀ / ▶ button. To exit 'Brightness' Setting, press OK again to return.
- b). Select 'Contrast' by using the ▲ / ▼ button, then press OK. You can adjust the Contrast by pressing the ◀ / ▶ button. To exit 'Contrast' Setting, press OK again to return.

3) Select Password using the ◀ / ▶ button, then press the OK button to enter the submenu.

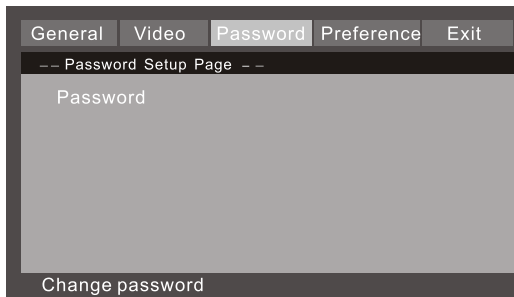

Press OK twice to enter the Password Change Page. Input the Old Password or the Default Password, the New Password, and the Confirmed New Password. Press OK to confirm the change.



Note: The default password is 8888.

---

4). With no disc inside the player or open operation, select 'Preference Page' using the ◀ / ▶ button, then press OK to enter the preference page.

- a. Select 'Audio' using the UP/DOWN button, then press ▶ to enter the submenu. Select the audio language you desire using the ▲ / ▼ button, then press OK to confirm the setting. Press ◀ to return.

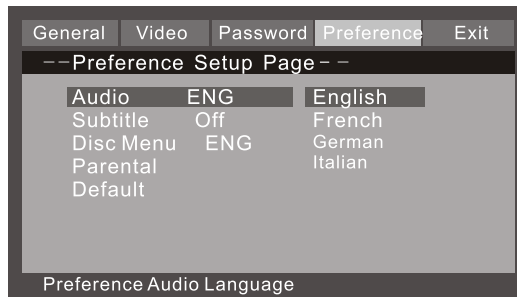

- b. Select 'Subtitle' using the ▲ / ▼ button, then press ▶ to enter the submenu. Select the desired subtitle language or Subtitle Off using the ▲ / ▼ button, then press OK to confirm the setting. Press ◀ to return.

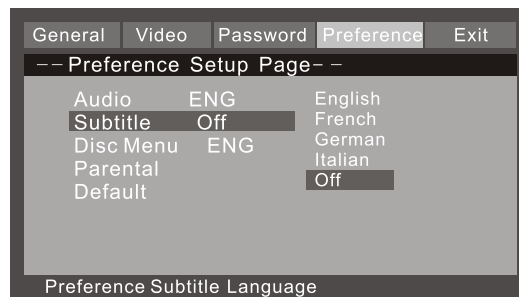

- c. Select 'Disc Menu' using the ▲ / ▼ button, then press ▶ to enter the submenu. Select the Disc Menu Language you desire using the ▲ / ▼ button, then press OK to confirm the setting. Press ◀ to return.

Note: Language and subtitle selection are only available for discs that are recorded in the above listed languages. If the selected language is not available, the player will display the original recorded language contained in the disc on the screen.





- 
- d. Select 'Parental' using the ▲ / ▼ button, then press ► to enter the submenu.

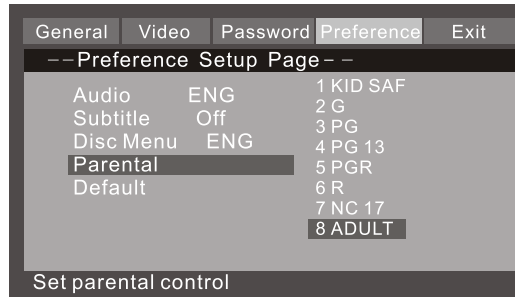

Select the parental level you desire using the ▲ / ▼ button for discs with lock-out function or multiple rating levels. These are listed from the lowest level (1 Kid Safe) to the highest level (8 Adult). Press OK and input 4 digit password, then press OK again to confirm the parental level setting.

NOTE: The level of 8 Adult is the factory default.  
The Default Password is 8888.

- e. Select 'Default' using the ▲ / ▼ button, then press ► to enter the submenu. Press OK to make the setting return to the factory-set mode.  
NOTE: The parental setting is not affected by the default reset function.

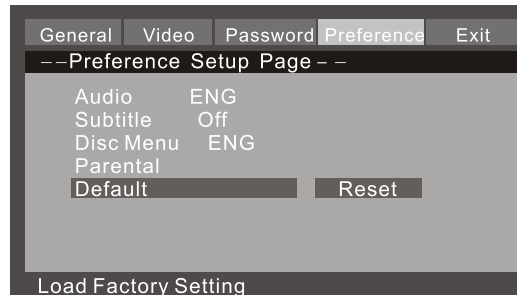

To avoid the possibility of the others using the default password to set the parental level and change the password, you can record this default password in another area and delete it from this manual. Some discs can be limited depending on the age of users while some discs cannot.

- 5) Select Exit by using the ◀ / ▶ button, press OK to exit.

---

## I. Basic Operation

ON/OFF	Turn the unit on/off
OPEN	Remove/load the disc
PLAY	Start Play/Execute item or setting
PAUSE	Still Picture
STOP	(1 time) Stop at the present playing point / (2 times) Stop playing
▼ ( ►► ON the remote)	Go to the next chapter, track or scene during play back(also used for Menu Navigation)
▲ ( ◀◀ ON the remote)	Go back to the previous chapter, track or scene during playback(also used for Menu Navigation)
► ( ►► ON the remote)	Scan forward at 2, 4, 8,16 or 32 times speed (also used for Menu Navigation)
◀ ( ◀◀ ON the remote)	Scan backward at 2, 4, 8, 16 or 32 times speed (also used for Menu Navigation)
OK (ON the remote)	Execute item or confirm setting
NUMBERS	Select item or setting
MENU	Display the main menu of the disc
REPEAT	Repeat playing title, chapter, or track
A-B	Repeat a specific portion from point A to point B of the disc
ANGLE	Change the viewing angles on the scene
SUBTITLE	Select the subtitle language and turn it on/off
AUDIO	Select the audio language
ZOOM	Enlarge an image to 2, 3, or 4 times the original size.
SETUP	Display the setup menu to select and set items,and exit the setup menu.
RETURN	To return to main menu when PBC on for VCD;To return to root menu during DVD playing and resume playing when in title menu or root menu by pressing it again
TITLE	Root title
SLOW	Slow

### Menu

A DVD is divided into two sections called titles and chapters. When you play a DVD, a root menu of the disc will appear on the screen of your TV or Monitor. The contents of the menu vary from disc to disc. Press MENU during playback to display the menu. Some DVDs only allow you to select disc playback options using the DVD root menu.

### ANGLE

During playback a disc, press 'ANGLE' to display the available angles for discs containing multi-angles\*, with the current angle number (1) and the total number of angles (2) displaying. Press 'ANGLE' to select another angle, then press again to exit and return to the normal viewing angle. The angle display will disappear automatically if the 'ANGLE' button is not pressed again within 3 seconds.

\*NOTE: Not all discs contain this feature.

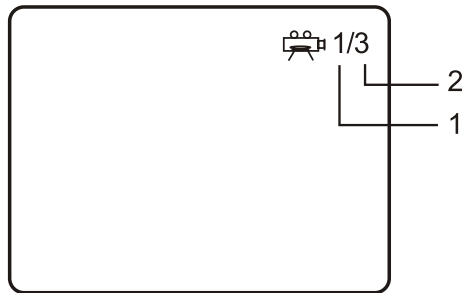

### SUBTITLE

During disc playback press 'SUBTITLE' to select the subtitle language you desire\*, with the current Subtitle Language Number (1) and the total Number of Subtitle Languages (2) displayed. If there are multiple languages press 'SUBTITLE' again to select another subtitle language. To turn subtitles OFF, press the 'SUBTITLE' button until 'Sub- title Off' is displayed. The Subtitle display will disappear automatically if the 'SUBTITLE' button is not pressed again within 3 seconds.

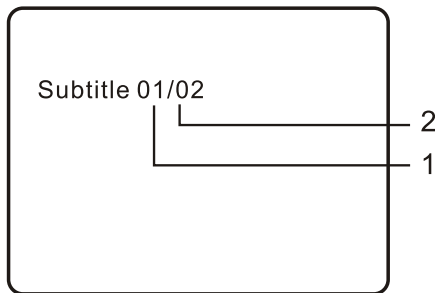

\* Some DVDs only allow access to this function through the DVD menu.

### AUDIO

During playback press 'AUDIO' to select the audio language you desire\*, with the current Audio Channel Number (1) and the total number of Audio Channels (2) displayed. Press AUDIO again to select another audio language. The audio display will disappear automatically if the 'AUDIO' button is not pressed within for 3 seconds.

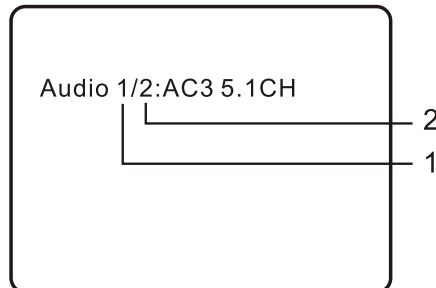

\* Some DVDs only allow access to this function through the DVD menu.

### ZOOM

During playback press 'ZOOM' to enlarge the picture by 2x, 3x or 4X with the current zoom multiple.(1)Press "zoom"one time ,the picture will be enlarged

---

2X.(2)Press "zoom" a second time ,the picture will be enlarged 3X.(3)  
Press "zoom" a 3rd time ,the picture will be enlarged 4X.(4)Press "zoom"  
a 4th time ,the picture will return to normal size.

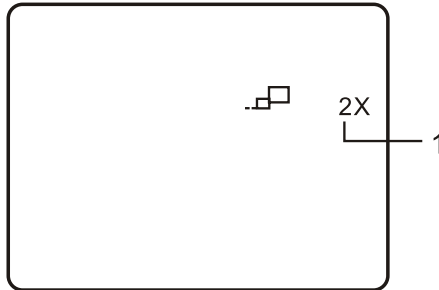

**A-B REPEAT**

a. During playback press a first time 'A-B' to set the Starting Point A

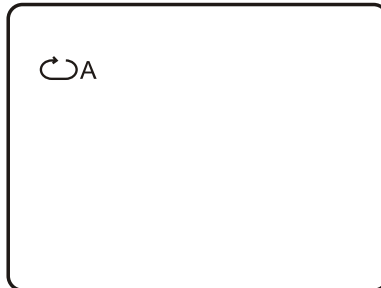

b. Press 'A-B' a second time to set the Ending Point B and the player will repeatedly play the part between Point A and Point B.



C. Press A-B a third time to cancel A-B repeat and resume normal playback.

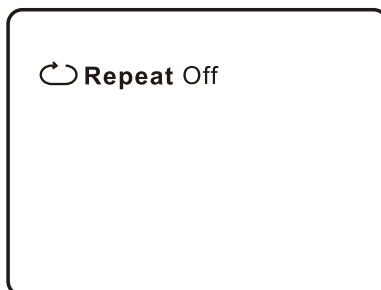

---

REPEAT

- a. During playback press 'REPEAT' once to repeatedly play the current chapter.

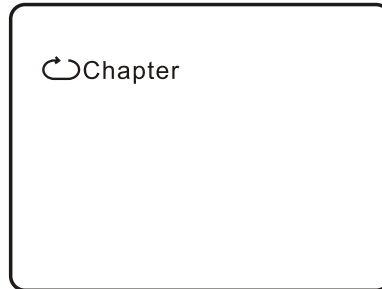

- b. During playback press 'REPEAT' again to repeatedly play the current title.

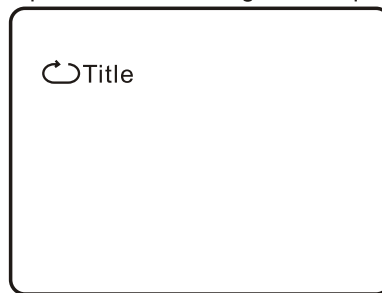

- c. During playback press 'REPEAT' a 3rd time to repeat all Chapters and Titles.



- d. Press 'REPEAT' a 4th time, to resume normal playback.

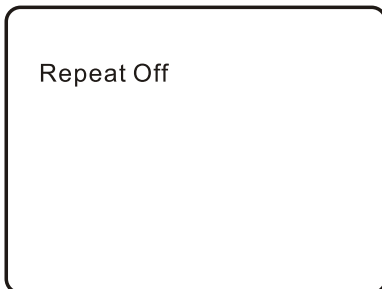

---

#### J. Playing MP3 file Discs

MP3 is a format for storing digital audio. An audio CD-quality song is compressed into the MP3 format with very little loss of audio quality while taking up much less disc space. CD-R /RW discs that have been encoded in MP3 format are compatible with this system.

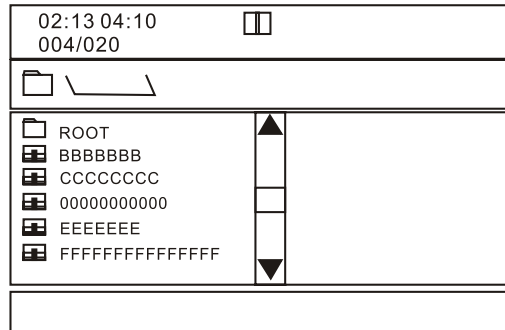

When an MP3 disc is inserted into the unit, the menu screen appears automatically. You can use the menu screen to select your desired folders and songs or the system plays the songs in the order they were burned into the disc.

1. Press the ▲ or ▼ button to choose a folder from the folder list on the left side of the screen.
2. Press ENTER to select the highlighted folder. The songs available under the folder will be listed.
3. Use ▲ or ▼ button to choose a song from the list. Press ENTER to select and begin playback of the highlighted song.

#### USING THE REPEAT FEATURE

The default mode for the Repeat feature is OFF(Folder). Pressing REPEAT consecutively changes the repeat options:

- o Repeat One (repeat playback of a song)
- o Repeat Folder (repeat playback of a specific folder)
- o Repeat off

As you toggle through the options, the repeat mode changes. The selected repeat mode loops repeatedly until you turn it off.

#### NOTICE

- "□" icon in front of a file name indicates that this is a folder, not an MP3 file.
- "MP3" icon in front of a file name indicates that this is an MP3 file.

#### K. Playing JPG files

- 1) Load the JPG Disc into tray.
  - 2) When previewing the file, pressing "ANGLE", "SUBTITLE", "AUDIO", "OSD", "SETUP", "NUMBER", "AB", "RETURN", a ∅ icon will appear on the display meaning that these options are not available.
  - 3) Press "STOP" or "MENU" to enter the root menu.
-

---

#### L. Connecting to a TV or another monitor

You can also connect the DVD player to a TV to enjoy high quality stereo sound and picture on another monitor.

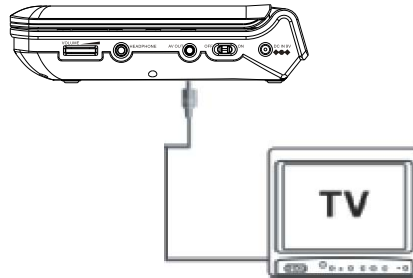

#### M. Rechargeable Battery Use

The player utilizes long-life Li polymer battery, built inside the unit, for portable power supply. Li battery features high storage capacity and low level of degradation. This means the battery doesn't have "Memory Effect" and thus can be recharged safely regardless of whether the battery is fully or partially discharged. A fully recharged battery can be obtained in 6H, Fully recharged battery can last about 2 hours.

#### Precautions related to Battery Recharge

1. The battery can be only recharged when turning power to OFF state, and keep continuous power supply, the red light will be on, indicating the unit is under recharging. When it's fully charged, the light will turn yellow.

#### Using and Maintaining Rechargeable Battery

1. The normal working temperature is: 0°C~45°C;
2. Always unplug AC/DC power supply for the unit whenever not playing, unless recharging the battery;
3. Heat will be generated during playing, it's normal, avoid long periods where the unit is playing and unattended;
4. Avoid having the unit collide with any objects, and place away from all possible heat sources or damp areas.

---

#### N. Specifications

Compatible DISC: VCD/DVD/CD/MP3  
Signal system: NTSC  
Panel size: 7 inch  
Frequency response: 20 Hz to 20 kHz  
Video output: 1 Vp-p/75 Ohm, unbalanced  
Audio output: 1.4Vrms/10kOhm  
Audio S/N: Better than 80 dB  
Dynamic range : Better than 85 dB  
Laser: Semiconductor Laser, Wave Length: 650 nm/795 nm  
Power source: DC 9-12V  
Power consumption: 10 W  
Operating temperature: 5~40° C  
Weight : 0.791 kg  
Dimensions (W x D x H): 199.6 x 160.5 x 41.5mm  
Battery Type: Li Polymer

#### O. Troubleshooting

PROBLEM	SOLUTION
No sound or distorted sound	Make sure your DVD is connected properly. Make sure all cables are securely inserted into the appropriate jacks.
Can't advance through a movie	You can't advance through the opening credits and warning information that appears at the beginning of movies because the disc is programmed to prohibit that action.
The icon (⊗) appears on screen	The feature or action cannot be completed at this time because: 1. The disc's software restricts it. 2. The disc's software doesn't support the feature (e.g., angles) 3. The feature is not available at the moment. 4. You've requested a title or chapter number that is out of range.
Picture is distorted	<ul style="list-style-type: none"><li>• The disc might be damaged. Try another disc.</li><li>• It is normal for some distortion to appear during forward or reverse scan.</li></ul>
No forward or reverse scan	<ul style="list-style-type: none"><li>• Some discs have sections that prohibit rapid scanning or title and chapter skip.</li><li>• If you try to skip through the warning information and credits at the beginning of a movie, you won't be able to. This part of the movie is often programmed to prohibit skipping through it.</li></ul>

*DESIGN AND SPECIFICATIONS ARE SUBJECT TO CHANGE WITHOUT NOTICE*

---